

# HYGIENE-WASTE BIN WITH INSERTION SLUICE AND VANITY FLAP WP179-1



202 x 344 x 115 mm

Capacity approx. 4 l

- Hygiene waste bin with insertion sluice and vanity flap in robust, germ-reducing and easy-care stainless steel (AISI 304).
- All-stainless steel housing; visible surfaces satin finished and brushed.  
Further available surfaces: see below.
- Equipped with removable hygiene bin. Capacity approx. 4 l.
- Accessible through hinged lid.
- Mounting: With four screws through key holes and one optional anti-theft hole in the back wall.
- Delivery includes fixing material.
- Weight, including single package: 3.6 kg



## Suggested text for specifications:

Hygiene waste bin with insertion sluice and vanity flap in stainless steel (AISI 304) for surface mounting. All-stainless steel housing; visible surfaces satin finished and brushed. Equipped with removable hygiene bin. Capacity approx. 4 l. Accessible through hinged lid. Delivery includes fixing material.

Dimensions: 202 x 344 x 115 mm

Article No. WP179-1

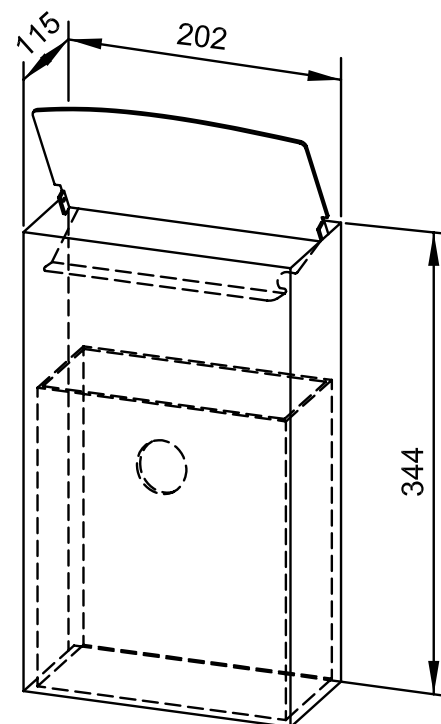

Available surfaces	ID No.
satin finished (standard)	727 250
highly polished	734 250
(coloured) plastic powder-coating	729 250

## Ernst Wagner GmbH & Co. KG

Ernst-Abbe-Straße 21 · D-72770 Reutlingen · Tel.: +49712151539-0 · Fax: -20  
info@wagner-ewar.de · www.wagner-ewar.de

WAGNER  
EWAR